

INSTRUCTION MANUAL

МУЗЦЕНТР
 МУЗЫКАЛЬНОЕ ОБОРУДОВАНИЕ
<https://muzcentre.ru>

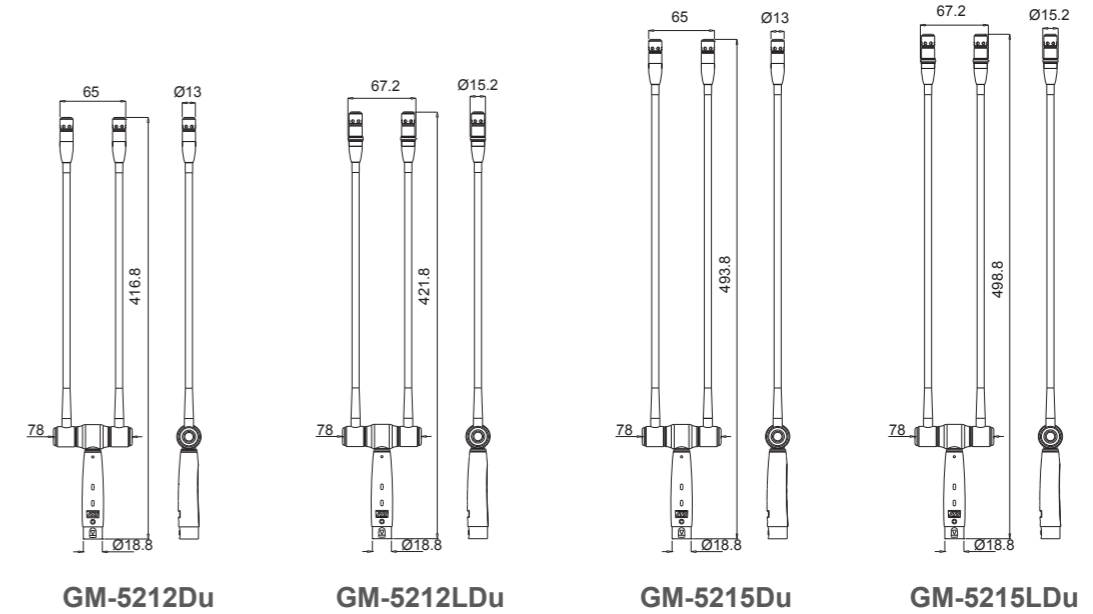
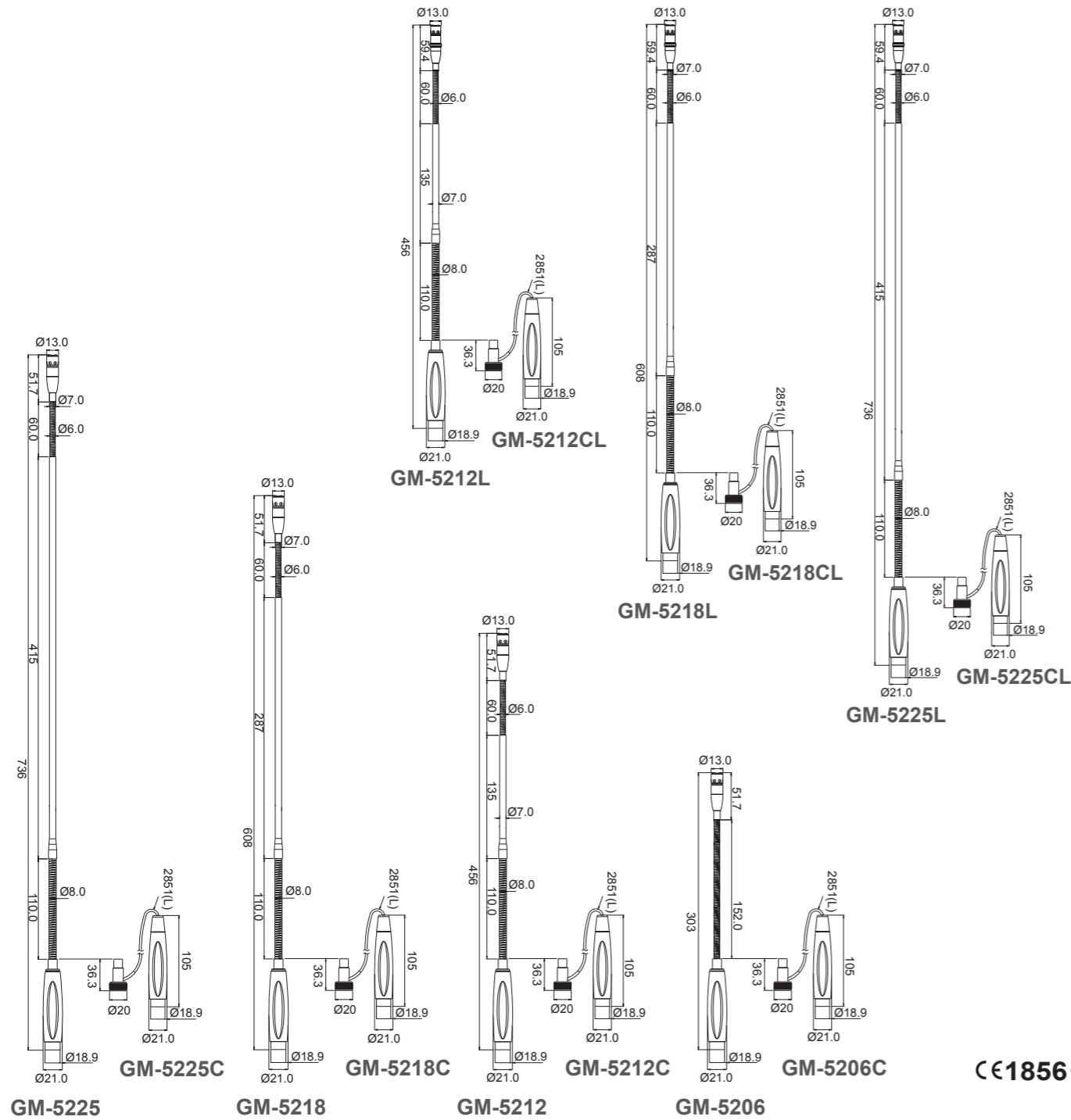

CE 1856 RoHS conform

GM Series Gooseneck Microphones



Features:

- The series are wide-range condenser microphones with supercardioid polar pattern, that they are optimal for speech and other demands in sound pickup situation.
- Screw-in type gooseneck microphones feature an additional 3m cable, offering extended length for greater positioning range.
- Plug-in type gooseneck microphones feature a 3P XLR connector, allowing it to be plugged directly into a matching panel jack or cable connector.
- The small diameter gooseneck permits high flexibility in proper position, and multiple gooseneck length is able to match different requirement.
- -10dB attenuation and 80Hz low cut are provided for best acoustical performance.

Installation:

GM-5206C/GM-5212C/GM-5218C/GM-5225C

GM-5206CL/GM-5212CL/GM-5218CL/GM-5225CL

1. Equipped with built-in power module, that an external 9V ~ 52V phantom power is required.
2. Screw microphone flange tightly onto a mounting stud of floor stand or conference table and make suitable cable length. (figure 1)
3. Adjust gooseneck for aiming the microphone toward the proper sound source. (figure 3)
4. Slip on windscreen over the microphone head to control breath and popping noise. (figure 4)

GM-5206/GM-5212/GM-5218/GM-5225

GM-5212L/GM-5218L/GM-5225L/GM-5212Du/5212LDu/GM-5215Du/5215LDu

1. Equipped with built-in power module, that an external 9V ~ 52V phantom power is required.
2. Plug connector directly into a 3P panel jack on floor stand or conference table. (Figure 2)
3. Adjust gooseneck for aiming the microphone toward the proper sound source. (Figure 3)
4. Slip on windscreen over the microphone head to control breath and popping noise. (Figure 4)

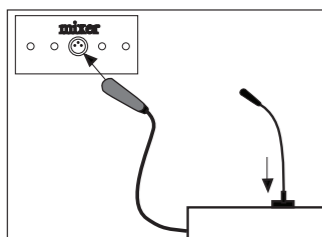

(Figure 1)

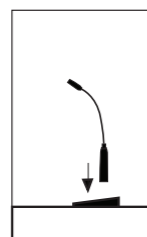

(Figure 2)

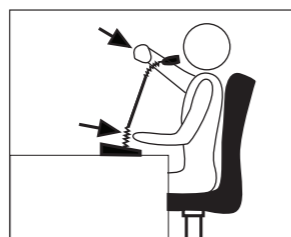

(Figure 3)

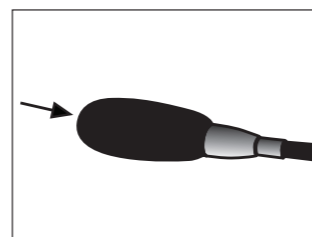

(Figure 4)

Specification:

Capsule type: Electret Condenser (for GM-5200L/GM-5200CL series)

Type..... Back Electret Condenser
 Frequency Response.. 80 ~ 18,000Hz
 Polar Pattern..... Supercardioid
 Output Connector..... XLR(M) type (power module) :
 GM-5206L/GM-5212L/GM-5218L/GM-5225L
 Screw 5/8" *27 :
 GM-5206CL/GM-5212CL/GM-5218CL/GM-5225CL
 Sensitivity (at 1,000Hz) -58dB(1mV)
 Impedance..... 220Ω
 Max. SPL for 1% THD... 125dB

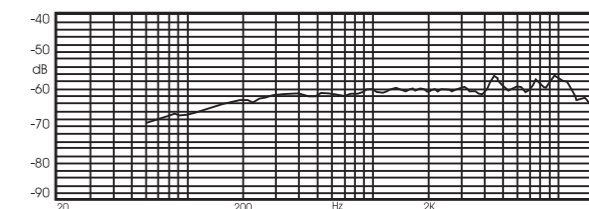

Condenser Frequency response

Capsule type: Electret Condenser (for GM-5200 Condenser/GM-5200C series)

Type..... Back Electret Condenser
 Frequency Response.. 80 ~ 18,000Hz
 Polar Pattern..... Supercardioid
 Output Connector..... XLR(M) type (power module) :
 GM-5206/GM-5212/GM-5218/GM-5225
 Screw 5/8" *27 :
 GM-5206C/GM-5212C/GM-5218C/GM-5225C
 Sensitivity (at 1,000Hz) -60dB(1mV)
 Impedance..... 220Ω
 Max. SPL for 1% THD.. 125dB

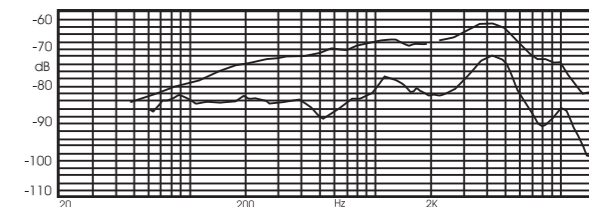

Dynamic Frequency response

Capsule type: Electret Condenser (for GM-5212Du/GM-5215Du/GM-5212LDu/GM-5215LDu)

Type..... Electret Condenser
 Frequency Response..... 80~18,000 Hz
 Directional Pattern..... Supercardioid
 Sensitivity..... -56±3 dB* (1.58mV) *0dB=1V /μbar
 Impedance..... 220Ω
 Max. SPL for 1% T.H.D. 125 dB
 Attenuation Switch..... -10db
 Low Frequency Roll-off 80Hz
 Output Connector..... 3P XLR-M type(power module)
 Power Supply..... 9-52 VDC Phantom power
 (LED standard operation voltage 48V) for 5212LDu/5215LDu
 Length..... 417mm GM-5212Du/5212LDu
 494mm GM-5215Du/5215LDu

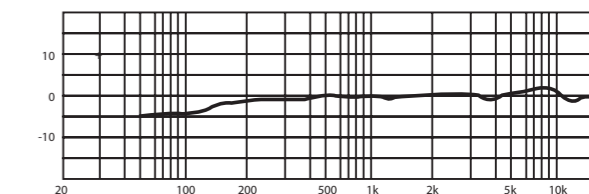

Accessories: Model Variations:

Windscreen	6" (152mm)	GM-5206/GM-5206C/GM-5206L/GM-5206CL
	12" (305mm)	GM-5212/GM-5212C/GM-5212L/GM-5212CL
	12" (417mm)	GM-5212Du/5212LDu
	15" (494mm)	GM-5215Du/5215LDu
	18" (608mm)	GM-5218/GM-5218C/GM-5218L/GM-5218CL
	25" (635mm)	GM-5225/GM-5225C/GM-5225L/GM-5225CL